

IoT 3.0

Direct-Connect Cell
Signal Amplifier

Index

About the IoT 3.0	1
Package Contents	2
IoT Retail Application Overview	3
IoT Retail Application Example Steps	4-6
IoT Security Application Overvie	7
IoT Security Application Example Steps	8-10
Status Light Patterns	11
Troubleshooting	13
Safety Guidelines	14
Specifications	17
Warranty	18

IoT 3.0

Direct-Connect Cell Signal Amplifier

The WilsonPro IoT 3.0 is a “Direct-Connect” solution for amplifying cellular network capable equipment and devices, including vending machines, ATMs, security panels, and cellular “hotspots”. The IoT 3.0 is “carrier agnostic” and pre-approved by all major cell carriers under FCC “part 20” rules. No additional carrier or FCC approvals are required.

Package Contents

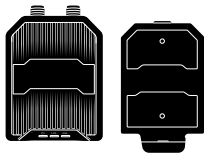

IoT 3.0
Cell Signal Amplifier &
Wall Mount Bracket



External Hinged
Antenna



POC
(Power over
Coax) Unit

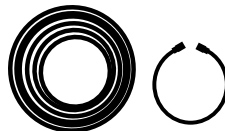

20' N to N Cable
& 1' SMA to SMA
Cable

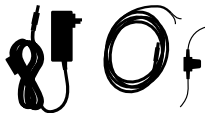

12V AC/DC Power
Supply & 12V DC
Hard-wire Cable

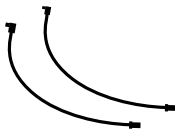

1' SMA to MMCX
& 1' SMA to MCX
Adapter Cables

IoT Retail Application Overview

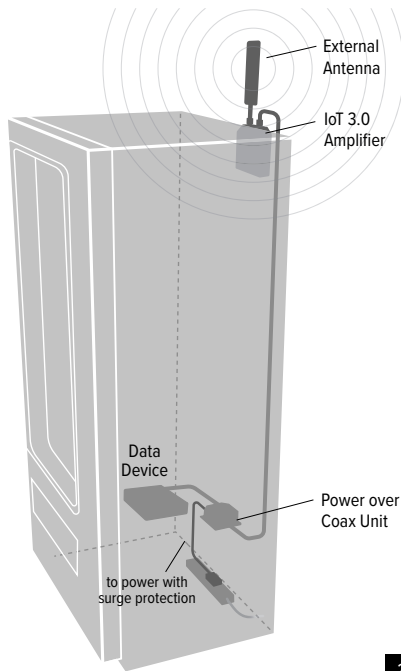
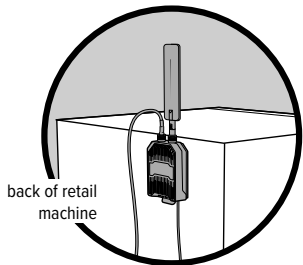

IoT Retail Application Example

STEP 1 Amplifier Placement

Select a location to install the signal amplifier that is away from excessive heat, direct sunlight, moisture and that has proper ventilation. Secure amplifier with mounting bracket.

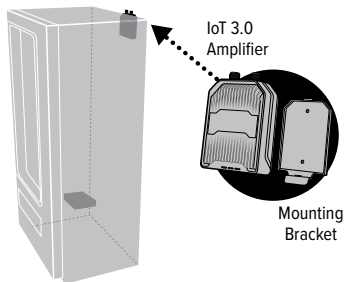

STEP 2 Attach External Antenna

Attach the external antenna to the top of the Signal Amplifier connector labeled **Outside Antenna**.

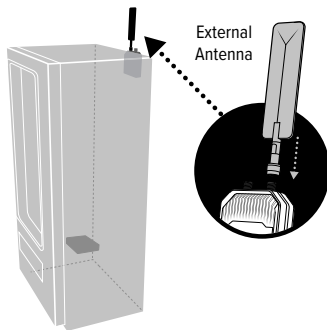

STEP 3 Connect Data Device to POC

Place the POC (Power over Coax) unit near the data device. Connect the included one foot cable to the data device, then to the connector on the POC, labeled **Data Device**. Finger tighten connectors only.

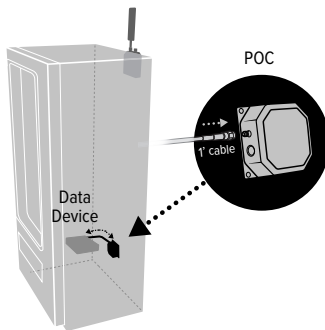

STEP 4 Connect POC to Amplifier

Connect the included 20 foot cable to the N-connector on the POC unit. Connect the other end of the cable to the N-connector labeled **Data Device** on the end of the amplifier. Finger tighten connectors only.

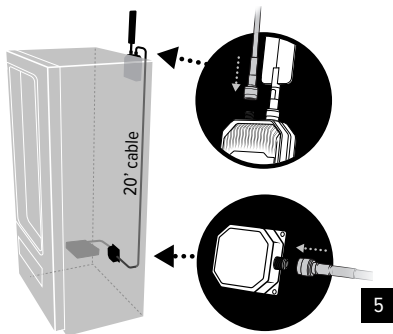

STEP 5 Power Up the Amplifier

Plug the power supply into a power outlet (or connect to a hardwired 12V DC source with the included hardware cable) and then connect the output cable to the power input of the POC Unit.

NOTE: The power supply output cable can be plugged directly into the end of the amplifier labeled  instead of the POC device if it is more convenient. Both methods will power the amplifier.

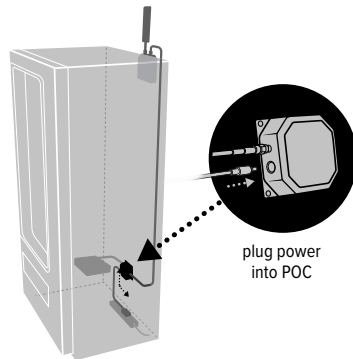

Important

- If the amplifier loses power, internal circuitry will bypass the amplifier switch so that a connection is made directly to the antenna.
- Safeguard your devices. Using a surge protector is always recommended for these applications.

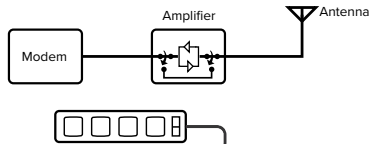

IoT Security Application Overview

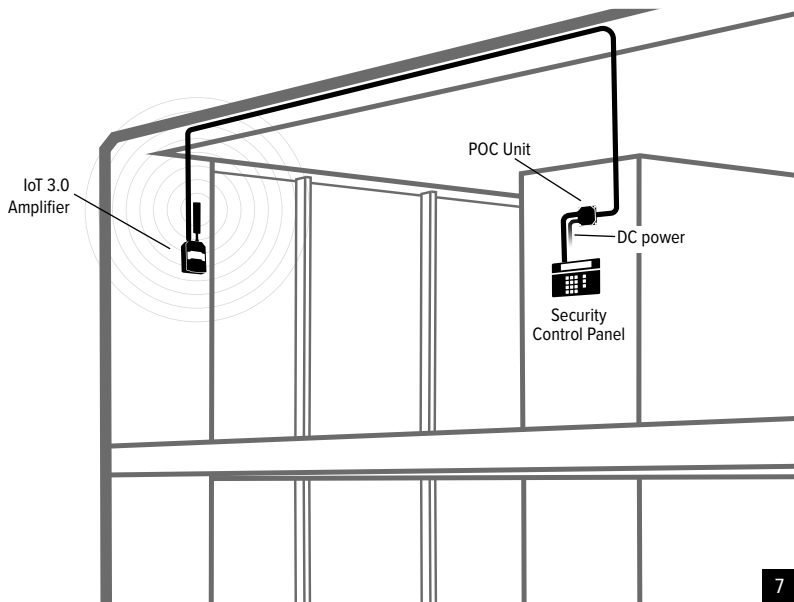

IoT Security Application Example

STEP 1 Amplifier Placement

Select a location to install the signal amplifier that is away from excessive heat, direct sunlight, moisture and that has proper ventilation. Secure amplifier with mounting bracket.

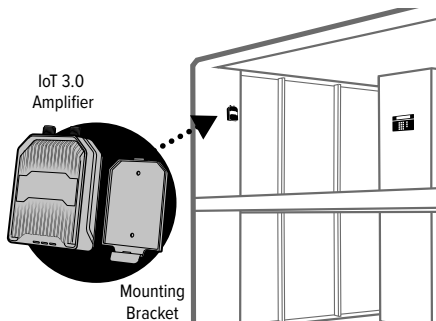

STEP 2 Attach External Antenna

Attach the external antenna to top of the amplifier labeled **Outside Antenna**.

NOTE: An outdoor antenna (e.g., omni) can be installed if desired. The antenna and cable can be purchased separately.

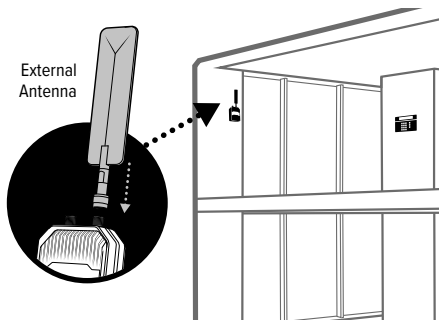

STEP 3 Connect Data Device to POC

Connect the included one foot cable to the security panel, then to the POC (Power over Coax), labeled **Data Device**.

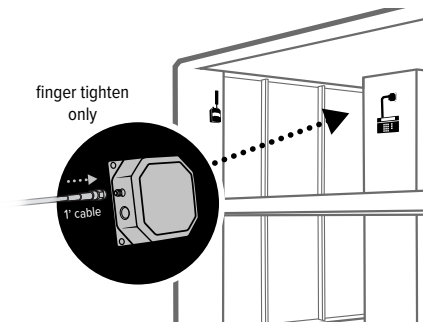

STEP 4 Connect POC to Amplifier

Connect the 20 foot cable to the POC unit labeled **AMP** and then connect cable to the amplifier labeled **Data Device**.

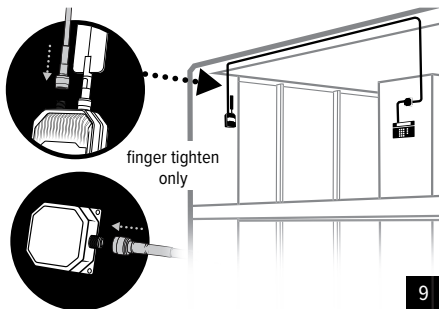

STEP 5 Power Up the Amplifier

Plug the Power Supply into a power outlet (or connect to a hardwired 12V DC source with the included hardware cable) and then connect the output cable to the power input of the POC Unit.

NOTE: the Power Supply output cable can be plugged directly into the end of the amplifier labeled  instead of the POC device if it is more convenient. Both methods will power the amplifier.

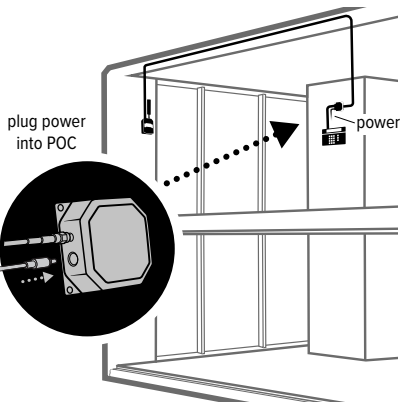

Important

- If the amplifier loses power, internal circuitry will bypass the amplifier switch so that a connection is made directly to the antenna.
- Safeguard your devices. Using a surge protector is always recommended for these applications.

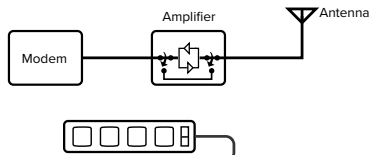

Status Light Patterns

SOLID GREEN D/L

A Solid Green D/L LED indicates that your amplifier is functioning properly and there are no issues with installation.

BLINKING GREEN U/L

The U/L LED will rapidly blink (flicker) Green to indicate the amplifier is functioning properly and actively communicating with the cell tower.

SOLID GREEN U/L

This indicates that U/L traffic has stopped and the amp will be entering a squelch/sleep state in about 90 seconds unless traffic resumes.

UL LED OFF

After the U/L LED has been Solid Green for about 90 seconds, meaning there has been no communication to the cell tower during that time, the U/L LED will turn Off indicating the amplifier is in a squelch/sleep state.

BLINKING GREEN/RED U/L and D/L

When the amplifier is initially powered on and it is operating at reduced gain to prevent oscillation (feedback), the U/L and D/L LEDs will be Solid Green for several seconds and then blink Green/Red for about 7 seconds, and then return to normal operation as described above. Refer to Troubleshooting section.

Status Light Patterns (cont.)

SOLID RED U/L and D/L

When a Band has been shutoff, the U/L and D/L LEDs will be Solid Red. This is due to a feedback loop condition called oscillation. This is a built in safety feature that causes a band to shut off to prevent harmful interference with a nearby cell tower. Refer to Troubleshooting section.

Power LED

The Power LED will be Solid Green when properly powered. It will never turn Red. If the LED is OFF, the amp is not receiving power.

Troubleshooting

FIXING RED LIGHT ISSUES

This involves Solid Red & Blinking Green/Red lights.

- Make sure all connections are tight. Un-plug and re-plug in power supply.
- Increase the distance (horizontally or vertically) between the external antenna/ amplifier and the data device. Un-plug and re-plug in power supply.

LIGHTS OFF

- Check connections on the power supply to see that it is firmly plugged into both the amplifier and the power source.

Safety Guidelines

Verify that both the Outside Antenna and the adapter extension cable are connected to the Signal Amplifier before powering up the Signal Amplifier.

Use only the power supply provided in this package. Use of a non-Wilson Electronics products may damage your equipment.

RF Safety Warning: Any antenna used with this device must be located at least 8 inches from all persons.

AWS Warning: The Outside Antenna must be installed no higher than 10 meters (31'9") above ground.

This is a **CONSUMER** device.

BEFORE USE, you **MUST REGISTER THIS DEVICE** with your wireless provider and have your provider's consent. Most wireless providers consent to the use of signal boosters. Some providers may not consent to the use of this device on their network. If you are unsure, contact your provider.

In Canada, **BEFORE USE** you must meet all requirements set out in ISED CPC-2-1-05.

You **MUST** operate this device with approved antennas and cables as specified by the manufacturer. Antennas **MUST** be installed at least 20 cm (8 inches) from (i.e., **MUST NOT** be installed within 20 cm of) any person.

You **MUST** cease operating this device immediately if requested by the FCC (or ISED in Canada) or licensed wireless service provider.

WARNING. E911 location information may not be provided or may be inaccurate for calls served by using this device.

This device may be operated **ONLY** in a fixed location (i.e..may operate in a fixed location only) for in-building use.

Safety Guidelines (cont.)

FOR MORE INFORMATION ON REQUIREMENTS SET OUT IN ISED CPC-2-1-05, SEE BELOW:

<http://www.ic.gc.ca/eic/site/smt-gst.nsf/eng/sf08942.html>

FOR MORE INFORMATION ON REGISTERING YOUR SIGNAL BOOSTER WITH YOUR WIRELESS PROVIDER, PLEASE SEE BELOW:

<https://www.weboost.com/carrier-registration>

Antenna Info

The following accessories are certified by the FCC to be used with the IoT 3.0 Direct-Connect Cell Signal Amplifier.

This radio transmitter 4726A-079 has been approved by Innovation, Science and Economic Development Canada to operate with the antenna types listed below, with the maximum permissible gain indicated. Antenna types not included in this list that have a gain greater than the maximum gain indicated for any type listed are strictly prohibited for use with this device.

	BAND 12/17	BAND 13	BAND 5	BAND 4	BAND 25/2
Outside Antenna maximum permissible antenna gain (dBi) 50Ω	2.0	2.0	2.0	5.0	5.0

Specifications

IoT 3.0 Direct-Connect Cell Signal Amplifier					
Model	460079				
FCC	PWO079				
IC	4726A-079				
Connectors	N-Connectors				
Antenna Impedence	50 Ohms				
Frequency	698-716 MHz, 746-787 MHz, 824-894 MHz, 1850-1995 MHz, 1710-1755/2110-2155 MHz				
Power output (Uplink) dBm	700 MHz B12/17 23.1	700 MHz B13 23.6	800 MHz B5 22.8	1700 MHz B4 23.8	1900 MHz B2 23.6
Power output (Downlink) dBm	-6.3	-6.8	-5.8	-6.8	-7.0
Noise Figure	5 dB (nominal)				
Isolation	> 40 dB				
Power Requirements	12V, 2.0A				

The term "IC" before the radio certification number only signifies that Industry Canada technical specifications were met. Each Signal Amplifier is individually tested and factory set to ensure FCC compliance. The Amplifier cannot be adjusted without factory reprogramming or disabling the hardware. The Signal Amplifier will amplify, but not alter incoming and outgoing signals in order to increase coverage of authorized frequency bands only. If the Signal Amplifier is not in use for five minutes, it will reduce gain until a signal is detected. If a detected signal is too high in a frequency band, or if the Signal Amplifier detects an oscillation, the Signal Amplifier will automatically turn the power off on that band. For a detected oscillation the Signal Amplifier will automatically resume normal operation after a minimum of 1 minute. After 5 (five) such automatic restarts, any problematic bands are permanently shut off until the Signal Amplifier has been manually restarted by momentarily removing power from the Signal Amplifier. Noise power, gain, and linearity are maintained by the Signal Amplifier's microprocessor. This device complies with Part 15 of FCC rules. Operation is subject to two conditions: (1) This device may not cause harmful interference, and (2) this device must accept any interference received, including interference that may cause undesired operation. Changes or modifications not expressly approved by Wilson Electronics LLC could void the authority to operate this equipment. This device contains licence-exempt transmitter(s)/receiver(s) that comply with Innovation, Science and Economic Development Canada's licence-exempt RSS(s). Operation is subject to the following two conditions: (1) This device may not cause interference, and (2) This device must accept any interference, including interference that may cause undesired operation of the device. Changes or modifications not expressly approved by Wilson Electronics LLC could void the authority to operate this equipment.

✔ 30 DAY MONEY-BACK GUARANTEE

All WilsonPro products are protected by WilsonPro 30-day money-back guarantee. If for any reason the performance of any product is not acceptable, simply return the product directly to the reseller with a dated proof of purchase.

✔ 3 YEAR WARRANTY

WilsonPro Amplifiers are warranted for three (3) years against defects in workmanship and/or materials. Warranty cases may be resolved by returning the product directly to the reseller with a dated proof of purchase.

Signal Amplifiers may also be returned directly to the manufacturer at the consumer's expense, with a dated proof of purchase and a Returned Material Authorization (RMA) number supplied by WilsonPro. WilsonPro shall, at its option, either repair or replace the product.

This warranty does not apply to any Signal Amplifiers determined by WilsonPro to have been subjected to misuse, abuse, neglect, or mishandling that alters or damages physical or electronic properties.

Replacement products may include refurbished WilsonPro products that have been recertified to conform with product specifications.

RMA numbers may be obtained by contacting Customer Support.

DISCLAIMER: The information provided by Wilson Electronics, LLC is believed to be complete and accurate. However, no responsibility is assumed by Wilson Electronics, LLC for any business or personal losses arising from its use, or for any infringements of patents or other rights of third parties that may result from its use.

MARKETING APPROVAL: Installer and end customer hereby grants to Wilson Electronics the express right to use installers or end customers company logo in marketing, sales, financial, and public relations materials and other communications solely to identify Customer as a Wilson Electronics customer.

Notes



1-866-294-1660





www.wilselelectronics.com





support@wilselelectronics.com

Notes



 1-866-294-1660  www.wilsoselectronics.com  support@wilsoselectronics.com

Notes

 1-866-294-1660  www.wilfonelectronics.com  support@wilfonelectronics.com



3301 East Deseret Drive, St. George, UT

 1-866-294-1660  www.wilsonelectronics.com  support@wilsonelectronics.com

Copyright © 2024 Wilson Electronics. All rights reserved. Wilson Electronics products covered by U.S. patent(s) and pending application(s) For patents go to: weboost.com/us/patents

NOT AFFILIATED WITH WILSON ANTENNA

GDE000599_Rev02_08.28.24