

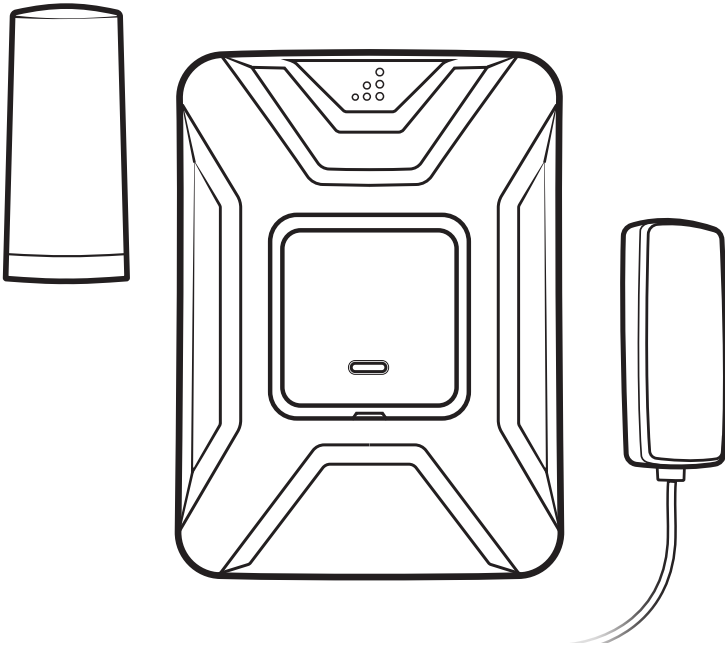

# DRIVE X FLEET

PROFESSIONAL VEHICLE CELL  
SIGNAL BOOSTER KIT



## Installation Guide

Use our  **weBoost App** to guide you through the installation.  
See inside page for more details.



# Download the weBoost App

Use our app to guide you through setting up a weBoost cell phone signal booster in your home, business, or vehicle. Boost every network, including 5G, right away.

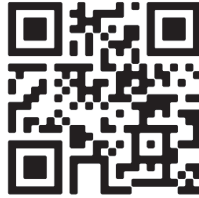

---

# Index

Package Contents .....	1
<b>STEP 1:</b> Drill Cable Entry Hole To Your Vehicle .....	2
<b>STEP 2:</b> Mount NMO Outside Antenna .....	5
<b>STEP 3:</b> Mount In-Vehicle Antenna .....	6
<b>STEP 4:</b> Wire The Power Supply .....	7
<b>STEP 5:</b> Connect Coax Cables To Booster .....	8
<b>STEP 6:</b> Connect Power Supply To Booster .....	9
Light Patterns .....	10
Troubleshooting .....	11
Safety Guidelines .....	13
Specifications .....	14
Warranty .....	15

---

# Package Contents

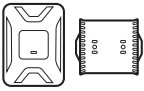

Drive X  
Booster  
& Bracket



Outside NMO  
Antenna +  
Connector  
Mounting Cable



In-Vehicle  
Antenna



Power  
Supply



Optional Antenna  
Extension Cable



Protective Tape  
For Installation



O-Ring Lubricant  
Packet

---

# Step 1: Drill Cable Entry Hole To Your Vehicle



**Identify a location for NMO outside antenna on the top of your vehicle that is:**

- Near the center of the roof
- At least 12 inches away from any other antennas
- At least 12 inches away from any windows (for best performance install on top of vehicle)



**Do a 'soft install' before drilling the hole for the cable entry.**

- Set up the system by routing the cable through an open door or window, completing the setup instructions, verifying the system works as desired, and then drilling the hole.

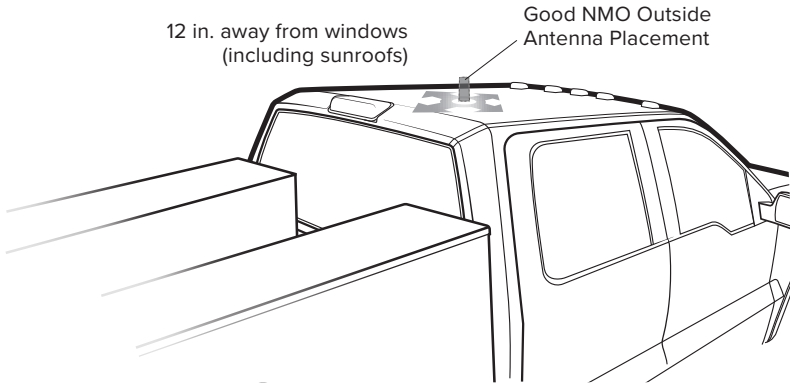

---

(STEP 1 cont.)

**After completing the 'soft install' and identifying NMO outside antenna location:**

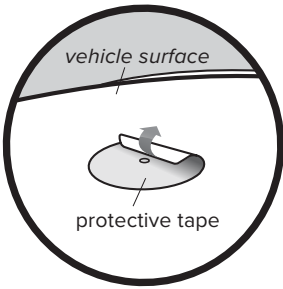

**Place the protective tape on the vehicle** in the desired location.

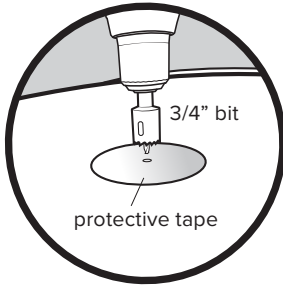

Using a 3/4" hole saw, **drill a hole** in the center of the protective tape.

(STEP 1 cont.)

After hole has been drilled, **insert NMO Mounting Cable** through (SMA connector end first) and remove collar.

Position threads of the cable mount above vehicle surface. **Apply included silicone grease to the o-ring** on the collar then screw the collar to the base mount. Ensure the mount is centered in the hole and **tighten with wrench**.

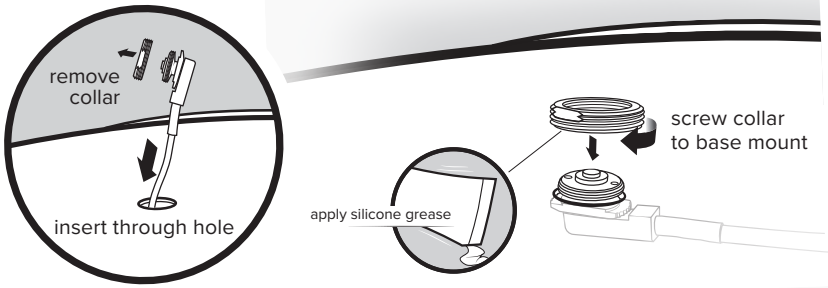

For a professional installation, we recommend routing the cable under the headliner and down through the side trim panel to the desired booster location on the floor of the vehicle.

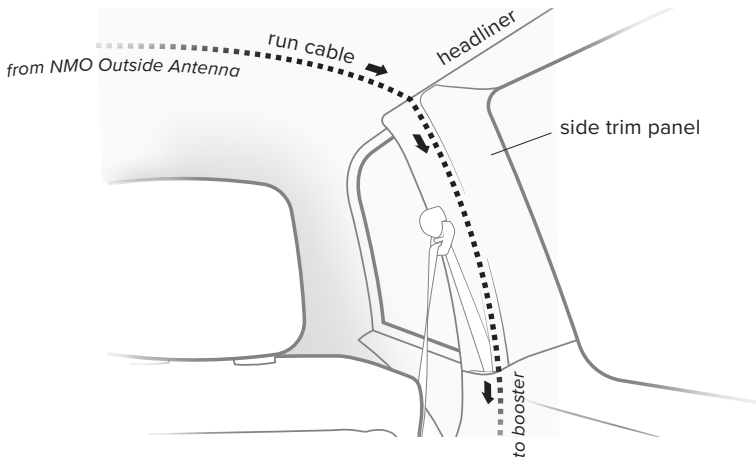

---

# Step 2: Mount NMO Outside Antenna

Before attaching the antenna, **apply a thin layer of silicone grease to the threads, only, to the NMO mount and to the o-ring on the antenna.** Screw the antenna onto the NMO mount and hand tighten into place.

NOTE: DO NOT apply silicone grease to the **antenna pin contact surface.**

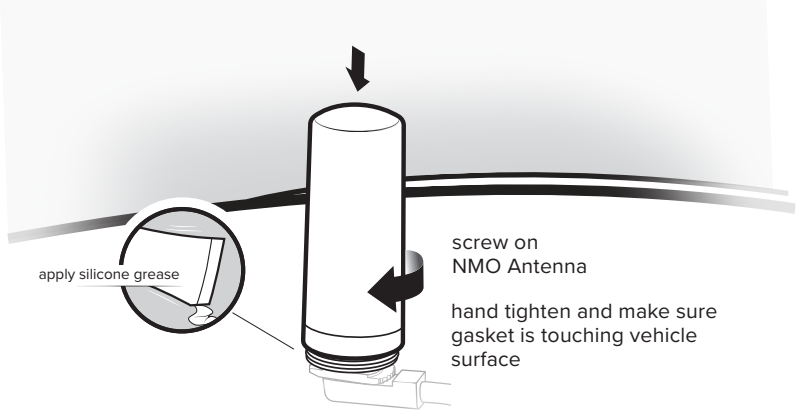



---

# Step 3: Mount In-Vehicle Antenna

**Identify a place to mount the in-vehicle antenna, either on the side of the seat or on the dash and mount.**

The location should be at least 18 inches but no more than 36 inches from where the cell phone device will be used. Adhesive and Velcro® mounting options are included.

**seat option**

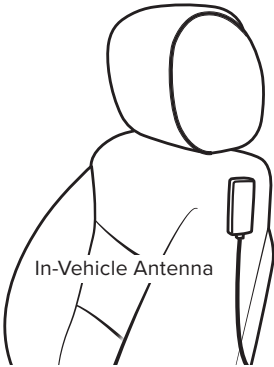

**dash option**

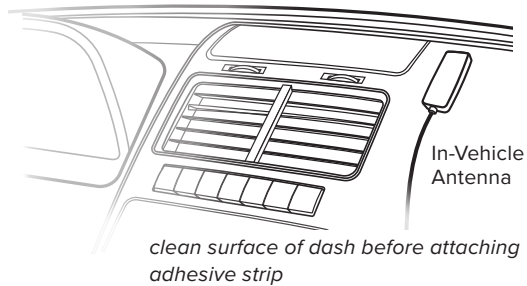

---

# Step 4: Wire The Power Supply

**Use steps below as a draft/template of the general install of the power supply.**

- 1 Before connecting the power supply, disconnect the vehicle battery leads to avoid any electrical shocks during installation.
- 2 Locate a place where cables are already running through the firewall (rear wall of engine bay) to the inside of the cabin.
- 3 Locate the same firewall hole from inside of the vehicle cabin.
- 4 Route the power cables of the power supply from the inside of the vehicle cabin out through firewall hole.  
Note: The cables must be routed inside to outside since the power supply brick won't fit through the firewall holes. The power supply brick should remain inside the vehicle cabin.
- 5 Connect the positive lead of the power supply (lead with red tape) to the disconnected positive (+) lead of the battery (not the positive terminal on the battery itself).
- 6 Connect the negative lead of the power supply (lead without tape) to the disconnected negative (-) lead of the battery (not the negative terminal on the battery itself).
- 7 Connect the positive (+) lead back to the vehicle battery.
- 8 Connect the negative (-) lead back to the vehicle battery.

NOTE: Having the power supply directly connected to the battery may drain the battery's life. Please review the vehicle's owner's manual for more information. Adding a "fuse tap" may be another solution. A "fuse tap" is an electrical part that functions as a power splitter and is meant to be installed in the car's fuse box, making the amp shut off when the vehicle's ignition switch is turned off.

---

# Step 5: Connect Coax Cables To Booster

Connect the cable from the NMO outside antenna to the port labeled “Outside Antenna” on the Drive X booster.

NOTE: Bracket can be used to fasten booster in a specific location if desired.

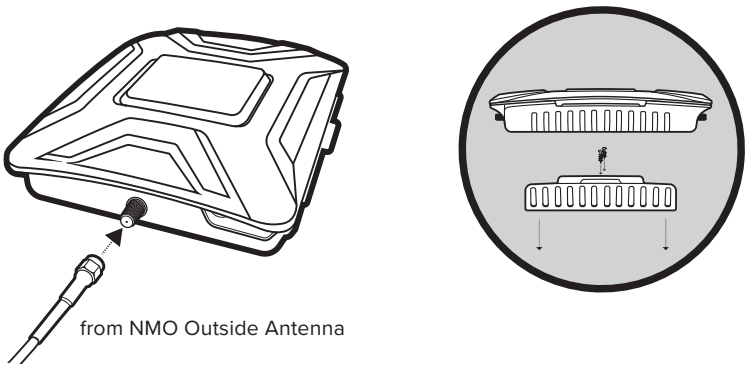

Connect the cable from the in-vehicle antenna to the port labeled “Inside Antenna” on the booster.

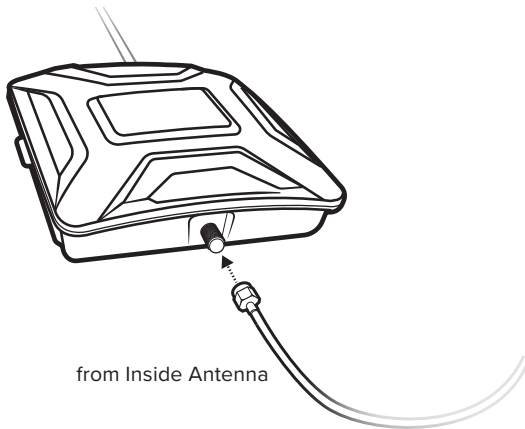

---

# Step 6: Connect Power Supply To Booster

Connect the power supply cord to the end of the Drive X labeled “Power.” Congratulations! Once your booster is running please allow some time for your phone to adjust to your new signal.

NOTE: Do NOT connect the power to the signal booster until you have connected both the Inside and outside antennas.

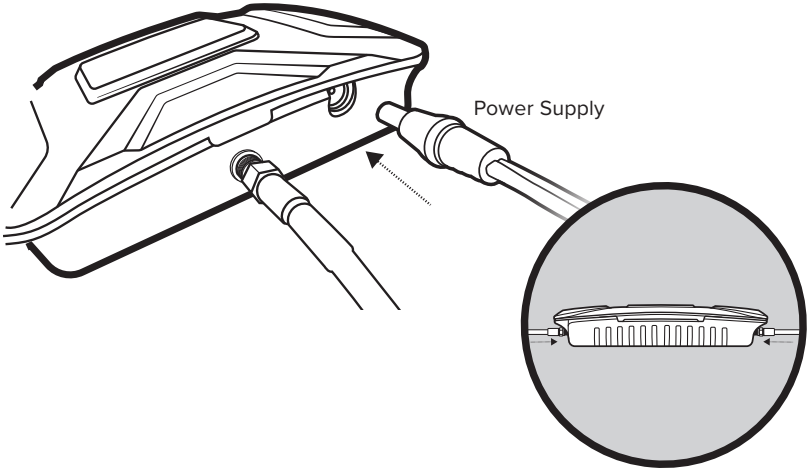

---

# Light Patterns

## Solid Green

This indicates that your booster is functioning properly and there are no issues with installation.

## Blinking Red, Then Solid Green

This indicates that one or more of the booster bands has reduced power due to a feedback loop condition called oscillation. This is a built in safety feature to prevent harmful interference with a nearby cell tower. If you are already experiencing the desired signal boost, then no further adjustments are necessary. If you are not experiencing the desired boost in coverage then refer to the Troubleshooting section.

## Solid Red

This is due to a feedback loop condition called oscillation. This is a built in safety feature that causes a band to shut off to prevent harmful interference with a nearby cell tower. Refer to Troubleshooting section.

## Light Off

If the Drive X signal booster's light is off, verify your power supply has power.

NOTE: The signal booster can be reset by disconnecting and reconnecting the power supply.

After troubleshooting you must initiate a new power cycle by disconnecting and then reconnecting power to the booster.

---

**NEED HELP?**



support.weboost.com



1-866-294-1660

---

---

# Troubleshooting

## FIXING BLINKING OR SOLID RED ISSUES

This section is only applicable if the booster is red or blinking red and you are not experiencing the desired signal boost.

- 1 Unplug the booster's power supply.
- 2 Relocate the inside and outside antenna further from each other. The objective is to increase the separation distance between them, so that they will not create this feedback condition discussed before.
- 3 Plug power supply back in.
- 4 Monitor the indicator light on your booster. If, after a few seconds of 'power on', a solid or blinking red light appears, repeat steps 1 through 3. Increase the separation distance until the condition is corrected and/or desired coverage area is achieved. Note: Horizontal separation of the two antennas typically requires a shorter separation distance than perpendicular separation.
- 5 If you are having any difficulties while testing or installing your booster, contact our weBoost Customer Support team for assistance (1-866-294-1660).

---

## FREQUENTLY ASKED QUESTIONS

### How can I contact customer support?

Customer Support can be reached Monday thru Friday by calling **1-866-294-1660**, or through our support site at [support.weboost.com](http://support.weboost.com).

### Why do I need to create distance between the booster and the antenna?

Antennas connected to a booster create spheres of signal. When these spheres overlap, a condition called oscillation occurs. Oscillation can be thought of as noise, which causes the booster to scale down it's power or shut down to prevent damage. The best way to keep these spheres of signal from overlapping is to maximize separation between the inside and outside antennas.

# Antenna Kit Options

The following accessories are certified by the FCC to be used with the Drive X.

This radio transmitter 4726A-460021 has been approved by innovation, Science and Economic Development Canada to operate with the antenna types listed below, with the maximum gain indicated. Antenna types not included in this list that have a gain greater than the maximum gain indicated for any type listed are strictly prohibited for use with this device.

	BAND 12/17	BAND 13	BAND 5	BAND 4	BAND 25/2
Outside antenna maximum permissible antenna gain (dBi) 50Ω	4.5	4.2	4.6	3.81	4.74
Inside antenna maximum permissible antenna gain (dBi) 50Ω	4.16	4.16	6.09	6.66	9.77

MOBILE INSIDE ANTENNA KIT OPTIONS				
Kit #	Coax Type	Ln(ft)	Antenna Type	Ω
314401	LMR-100	10	Low Profile In-Vehicle SMA	50

MOBILE OUTSIDE ANTENNA KIT OPTIONS				
Kit #	Coax Type	Ln(ft)	Antenna Type	Ω
311229	LMR195	15	OTR Antenna Truck Edition	50
301126	LMR-100	10	Mini-Mag Antenna SMA	50
314405	RG-58	14	NMO Vehicle Antenna	50
311125	RG-174	12.5	12" Mag Mount	50

---

# Safety Guidelines

Use only the power supply provided in this package. Use of a non-weBoost product may damage

Low profile antennas must have at least 1.5' separation distance from all active users.

Connecting the Signal Booster directly to the cell phone with use of an adapter will damage the cell phone.

RF Safety Warning: Any antenna used with this device must be located at least 8 inches from all persons.

## This is a CONSUMER device.

**BEFORE USE**, you **MUST REGISTER THIS DEVICE** with your wireless provider and have your provider's consent. Most wireless providers consent to the use of signal boosters. Some providers may not consent to the use of this device on their network. If you are unsure, contact your provider.

In Canada, **BEFORE USE** you must meet all requirements set out in ISED CPC-2-1-05.

You **MUST** operate this device with approved antennas and cables as specified by the manufacturer. Antennas **MUST** be installed at least 20 cm (8 inches) from (i.e., **MUST NOT** be installed within 20 cm of) any person.

You **MUST** cease operating this device immediately if requested by the FCC (or ISED in Canada) or licensed wireless service provider.

**WARNING.** E911 location information may not be provided or may be inaccurate for calls served by using this device.

## FOR MORE INFORMATION ON REQUIREMENTS SET OUT IN ISED CPC-2-1-05, SEE BELOW:

<http://www.ic.gc.ca/eic/site/smt-gst.nsf/eng/sf08942.html>

## FOR MORE INFORMATION ON REGISTERING YOUR SIGNAL BOOSTER WITH YOUR WIRELESS PROVIDER, PLEASE SEE BELOW:

**T-Mobile/Sprint/MetroPCS:** <https://www.t-mobile.com/support/coverage/register-a-signal-booster>

**Verizon Wireless:** <http://www.verizonwireless.com/wcms/consumer/register-signal-booster.html>

**AT&T:** <https://securec45.securewebsession.com/attsignalbooster.com/>

**U.S. Cellular:** <http://www.uscellular.com/uscellular/support/fcc-booster-registration.jsp>



# Specifications

## Drive X

Product Number	U471010				
Model Number	460021				
FCC ID:	PWO460021				
IC ID:	4726A-460021				
Connectors	SMA-Female				
Antenna Impedance	50 Ohms				
Frequency	699-716 MHz, 729-756 MHz, 777-786 MHz, 824-894 MHz, 1850-1995 MHz, 1710-1755 MHz/2110-2155 MHz				
	Maximum Power				
Power output for single cell phone (Uplink) dBm	700 MHz Band 12/17 24.84	700 MHz Band 13 24.35	800 MHz Band 5 23.4	1700 MHz Band 4 21.3	1900 MHz Band 2 24.43
Power output for single cell phone (Downlink) dBm	700 MHz Band 12/17 2.87	700 MHz Band 13 2.79	800 MHz Band 5 2.8	2100 MHz Band 4 2.0	1900 MHz Band 2 1.92
Noise Figure	5 dB nominal				
Isolation	> 90 dB				
Power Requirements	6 V 2 A				

Each Signal Booster is individually tested and factory set to ensure FCC compliance. The Signal Booster cannot be adjusted without factory reprogramming or disabling the hardware. The Signal Booster will amplify, but not alter incoming and outgoing signals in order to increase coverage of authorized frequency bands only. If the Signal Booster is not in use for five minutes, it will reduce gain until a signal is detected. If a detected signal is too high in a frequency band, or if the Signal Booster detects an oscillation, the Signal Booster will automatically turn the power off on that band. For a detected oscillation the Signal Booster will automatically resume normal operation after a minimum of 1 minute. After 5 (five) such automatic restarts, any problematic bands are permanently shut off until the Signal Booster has been manually restarted by momentarily removing power from the Signal Booster. Noise power, gain, and linearity are maintained by the Signal Booster's microprocessor.

The term "IC" before the radio certification number only signifies that Industry Canada technical specifications were met. This device complies with Part 15 of FCC rules. This device contains licence-exempt transmitter(s)/receiver(s) that comply with Innovation, Science and Economic Development Canada's licence-exempt RSS(s). Operation is subject to the following two conditions: (1) This device may not cause interference, and (2) This device must accept any interference, including interference that may cause undesired operation of the device. Changes or modifications not expressly approved by weBoost could void the authority to operate this equipment.

**NEED HELP?**



support.weboost.com



1-866-294-1660



## 2 YEAR WARRANTY

weBoost Signal Boosters are warranted for two (2) years against defects in workmanship and/or materials. Warranty cases may be resolved by returning the product directly to the reseller with a dated proof of purchase.

Signal Boosters may also be returned directly to the manufacturer at the consumer's expense, with a dated proof of purchase and a Returned Material Authorization (RMA) number supplied by weBoost. weBoost shall, at its option, either repair or replace the product.

This warranty does not apply to any Signal Boosters determined by weBoost to have been subjected to misuse, abuse, neglect, or mishandling that alters or damages physical or electronic properties.

Replacement products may include refurbished weBoost products that have been recertified to conform with product specifications.

RMA numbers may be obtained by contacting Customer Support

**DISCLAIMER:** The information provided by weBoost is believed to be complete and accurate. However, no responsibility is assumed by weBoost for any business or personal losses arising from its use, or for any infringements of patents or other rights of third parties that may result from its use.





3301 East Deseret Drive, St. George, UT

 1.866.294.1660  [www.weboost.com](http://www.weboost.com)  [support.weboost.com](mailto:support.weboost.com)

Copyright © 2019 weBoost. All rights reserved.  
weBoost products covered by U.S. patent(s) and pending application(s)  
For patents go to: [weboost.com/us/patents](http://weboost.com/us/patents)